

INFRARED SENSORS USER'S GUIDE

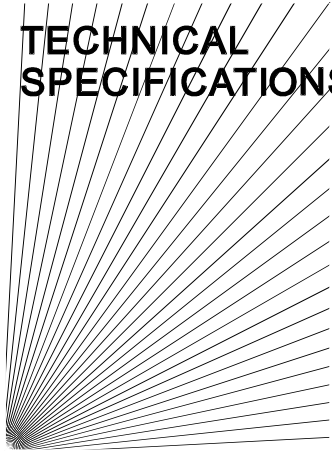

UNIVERSAL INFRARED SENSORS FOR AUTOMATIC MODEL:YET606

TECHNICAL SPECIFICATIONS



Technology	: Infrared
<u>RECEIVER</u>	
RANGE	: ≤15m
	: Range can be reduced to 30% in bad weather conditions: for, rain, dust, etc.
Infra-Red Frequency	: 1.92 KHz
POWER SUPPLY	: 12 to 24V DC/AC
WAVE LENGTH	: 940nm
INPUT	: RX 15mA - TX 30mA
OPERATING TEMPERATURE	: -10°C to 70°C
RELAY OUTPUT	: 1A max 36V
DIMENSIONS	: 49.2 x 76 x 21.6 mm

CONNECTING THE SENSOR

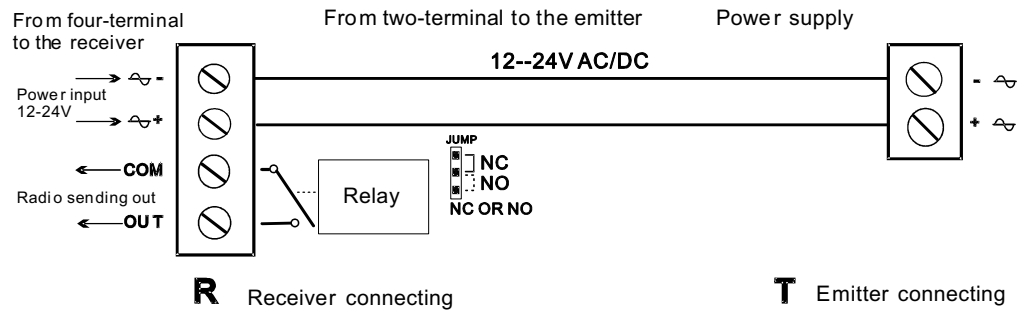
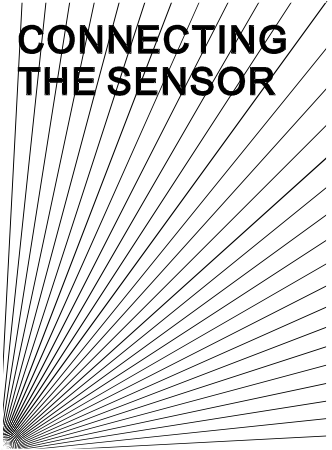

Installation

The best install height should be 20 cm, install distance to be no smaller than 2 meters. Install should make red outside the protection equipment perpendicular to place, and is on-line at same level. Install should install first to receive part, install blast-off part again. When together at always line, receive the OFF light in the machine in order to put out, then fix, connect the line to install completion namely.

Attention:

Because this product shoot power compare big, so when shoot machine with receive the machine distance too near hour will appear have no the phenomenon of the reaction, at this time should draw back them one meter at least behind again try. When install distance very near, discover not intelligent phenomenon, can shoot and receive medium of the condensing lens remove, can immediately raise an intelligent degree.

MOUNTING THE SENSOR

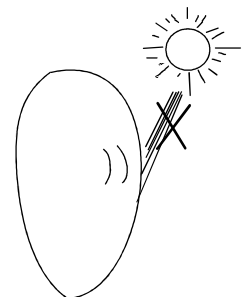
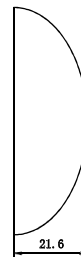
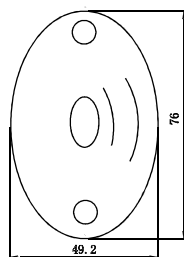
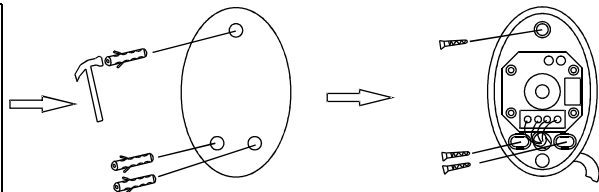
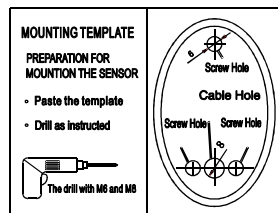
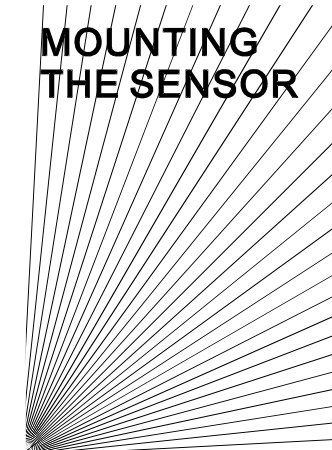

Avoid the sun keeps shoot